

HITEC HFP-30

Hitec Digital Servo Programmer &
Servo Tester for All Servo Brands

Instruction Manual

Introduction

Congratulations on the purchase of the HFP-30. The HFP-30 is designed to program all Hitec Digital Programmable Servos (D Series, 5xxx/7xxx, and Brushless) as well as test any brand servo.

Contents

Layout

Powering On

Main Screens

1. Main Programming Screen
2. Main Servo Test Screen

Test Mode

1. Manual Test
2. Auto Test
3. Auto Deadband Testing
4. Settings

Programming

D Series Program Mode

- 1) Set EPA/Neutral
- 2) Servo Sync
- 3) Set Rotation (CW_CCW)
- 4) Set Deadband (DB_Width)
- 5) Set Speed
- 6) Set ID (ID_Read)
- 7) Set Failsafe
- 8) Set Soft Start
- 9) Factory Reset (Factory Default Set)

5/7 Series Program Mode (For 5xxx*/7xxx Servos)

- 1) Set EPA/Neutral
- 2) Servo Sync
- 3) Set Rotation (CW_CCW)
- 4) Set Deadband (DB_Width)
- 5) Set Speed
- 6) Set Failsafe
- 7) Set Resolution
- 8) Set Overload Protection (OLP)
- 9) Factory Reset (Factory Default Set)

B Series Program Mode (BLDC Servos)

- 1) Set EPA/Neutral
- 2) Servo Sync
- 3) Set Rotation (CW_CCW)
- 4) Set Deadband (DB_Width)
- 5) Set Speed
- 6) Set Failsafe
- 7) Set Soft Start
- 8) Factory Reset (Factory Default Set)

Contents

Layout

1. Adjust Dial
2. Back Button
3. Analog Dial for Pulse Adjustment
4. USB Port
5. Test/Program Select Switch
6. Battery/Receiver Port
7. Servo Sync Port
8. Servo Port
9. LCD

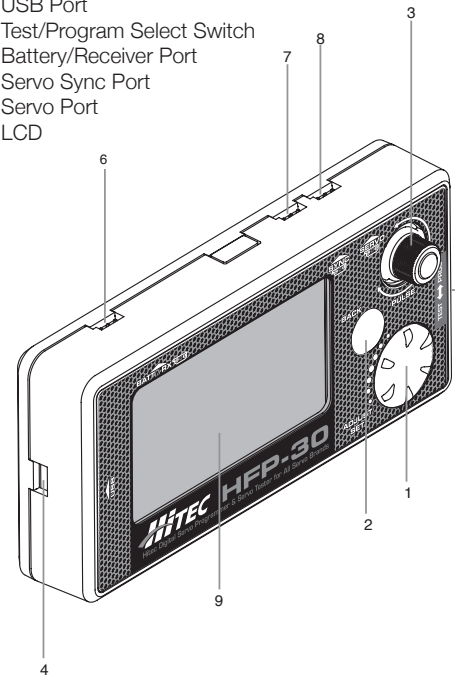

Powering On

The HFP-30 is powered by a user provided 4.8VDC to 7.4VDC battery pack plugged into the Batt/RX slot. Optionally, a receiver with the correct adapter can power the unit.

Note: Make sure the battery voltage corresponds to the servos being used. Do not use a 7.4V battery with a servo designed for 6V and under, or damage may occur to the servo.

Main Screens

Depending on the position of the Test/Program select switch, the following screens will appear when powered on. Once powered on,

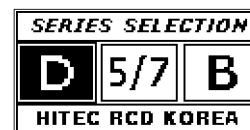

it is possible to toggle between the screens using the Test/Program switch.

Main Programming Screen

Use the Adjust Dial to switch between the three different series of servos. Once the correct one is highlighted, press the Adjust Dial to enter.

Main Servo Test Screen

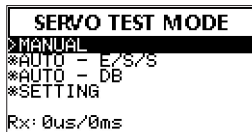

Use the Adjust Dial to select the desired test function. Once the function is highlighted, press the Adjust Dial to enter.

Test Mode

In this mode, all manufacturer's servos can be tested for operation. To begin testing servos, plug a servo into the servo slot on the programmer and install the correct battery type in the battery slot. Move the select switch to the TEST position.

1. Manual test

Using the Adjust Dial, highlight Manual, and press then Adjust Dial to enter.

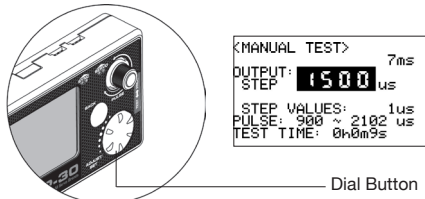

At this point it is possible to move the servo using the Pulse Dial. As the dial is turned the OUTPUT box will show the current position of the servo in microseconds.

Pressing the Adjust Dial will switch to STEP mode allowing much finer control. Use the Adjust Dial to adjust the microseconds. Press again to exit.

Press the BACK button to exit the menu.

1. AUTO - E/S/S Test (Extreme, Sweep, Step)

Use the Adjust Dial to highlight AUTO - E/S/S and press it to enter the menu.

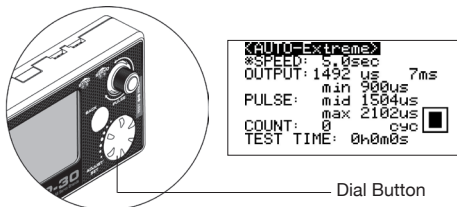

In the Auto Test menu, it is possible to switch between Extreme, Sweep, and Step modes by turning the Adjust Dial. Each mode will display a cycle count and how much time has passed during the test. Before a mode is selected, the Pulse Dial will move the servo manually.

Here's a brief explanation of the different modes:

Extreme – Moves the servo through minimum, middle (neutral), and maximum endpoints. Speed of the total movement can be adjusted. If the movement is set faster than the servo is rated, then the servo will not be able to move to each end point before changing direction. The speed ranges from 0.1 second to 5.0 second.

Sweep – Moves the servo through minimum and maximum endpoints at an adjustable speed. The speed of the Sweep is adjustable between 2.4 seconds/cycle to 120 seconds/cycle.

Step – Moves the servo through the minimum and maximum positions at an adjustable Pulse Step. The Step range is 0.25 microseconds to 100.0 microseconds.

AUTO-Extreme

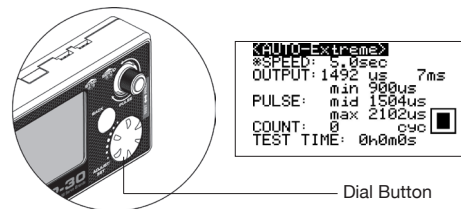

With this highlighted, press the Adjust Dial. This will select the Test Mode and show a 'Pause' indicator in the lower right of the screen. Pressing the Adjust Dial again will select 'Play' and the servo will start moving. The servo speed is adjusted by turning the Adjust Dial. Press the Adjust Dial to 'Pause' or the BACK button to switch to a different Auto Test Mode.

AUTO-Sweep

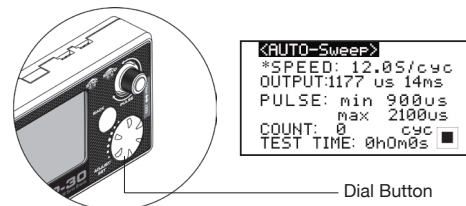

With this highlighted, press the Adjust Dial. This will select the Test Mode and show a 'Pause' indicator in the lower right of the screen. Pressing the Adjust Dial again will select 'Play' and the servo will start moving. The cycle speed is adjusted by turning the Adjust Dial.

Press the Adjust Dial to 'Pause' or the BACK button to switch to a different Auto Test Mode.

AUTO-Step

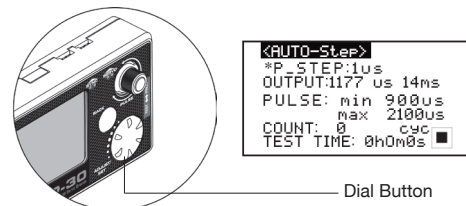

With this highlighted, press the Adjust Dial. This will select the Test Mode and show a 'Pause' indicator in the lower right of the screen. Pressing the Adjust Dial again will select 'Play' and the servo will start moving. The Step increments are adjusted by turning the Adjust Dial.

Press the Adjust Dial to 'Pause' or the BACK button to switch to a different Auto Test Mode.

AUTO-DB (Deadband)

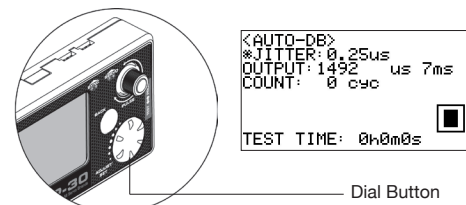

Use the Adjust Dial to highlight AUTO-DB and press it to enter the menu. The Auto Test will check the servos Deadband. When in the menu, press the Adjust Dial to begin the Test. A 'Play' symbol will be displayed in the lower right screen. Turning the Adjust Dial will adjust the microsecond range. The jitter range is 0.25 microseconds to 100.0 microseconds.

Press the BACK button to exit.

Settings

```

<TEST SETUP>
<GYRO MODE> Off
*PULSE_w: mid 1504us
           min 900us
           max 2102us
*PULSE_p: 7ms
*STEP VALUES: 1us
1/2

```

The Settings menu is where specific test parameters can be set for all servo test modes. Use the Adjust Dial to highlight SETTING and press it to enter the menu.

To make adjustments to the various settings, use the Adjust Dial to highlight it and then press the dial to enter editing mode. To change the value, use the Adjust Dial. Either press it again to confirm and exit or press the BACK button to exit without saving. The different features that can be edited are:

GYRO MODE (ON/OFF): This is for use with specifically designed tail rotor servos. These servos generally use a different neutral and endpoints than other servos. Turning this feature on will automatically reset the pulse widths and frame rate for testing. Do not use this setting unless the servo being tested states it is a high frame rate tail rotor servo.

PULSE_w (Pulse Range): For setting the Pulse Width Test parameters for a servo. The adjustments are made to middle (neutral), minimum and maximum endpoints. To edit a point, highlight it using the Adjust Dial and then press the dial to begin editing.

The range for each is:

Mid: 1100 – 1900 microseconds
 Min: 100 – 1500 microseconds
 Max: 1500 – 2520 microseconds

Note: Adjust these settings with caution. If the pulse is too wide, the servo may stall which will cause damage.

PULSE_p (Frame Rate): The Frame Rate is how fast the signal is sent to the servo. The lower the number the faster the signal is sent. The range is from 3 milliseconds to 30 milliseconds. Caution is required as analog servos cannot handle frame rates faster than 14 milliseconds. Doing so will cause damage.

STEP VALUES: The increments moved when testing. The range is from 0.25 microseconds to 1 microsecond.

TEST: The speed and number of cycles to test at when using AUTO E/S/S mode.

The ranges are:

Speed: 0.1 second to 5.0 seconds.
 Count: 0 - 50000 cycles.

LCD Contrast: Change the LCD screen contrast for better personalized viewing.

SET Default: Revert all settings to their defaults.

Programming

To program the different series of Hitec digital servos, plug the servo into the SERVO port of the programmer and the battery or receiver into the BATT/RX port. Once connected, move the selector switch to the PROG position. On the SERIES SELECTION screen, use the Adjust Dial to select the appropriate series of the servo connected. Press the dial to enter the menu. Each setting is selected with the Adjust Dial. Once highlighted, press the dial to edit.

Note: It is highly recommended that the servo being programmed is not connected to any linkage.

D Series Program Mode

1. EPA Neutral Settings

```

>>D.Series SetLists<<
>EPA Neutral Settings
65392/8096/16503
+CW_CCW      : CW
+DB_Width    : 1
+Speed       : 100%
+ID_Read     : 1/2

```

Press the Adjust Dial to enter the menu. If the Pulse Dial is off center, the program will ask that the dial is center so the indicator is at 12 o'clock. Once adjusted, the Neutral Settings screen will appear. Use the Adjust Dial to elect either to change the Neutral position or to skip and move on to the endpoints.

To change the Neutral position, highlight NEUTRAL, and press the Adjust Dial to enter the edit mode. To make an adjustment, use the Pulse Dial. To save the setting to the servo, press the Adjust Dial, otherwise, press the BACK button to exit without making a change.

Note: Changing the neutral position to an extreme will affect the throw of the servo's endpoints. Try to never vary the position too far from nominal. Also, if the neutral position is programmed, then the endpoints must be programmed.

The endpoints can be programmed without setting the neutral position. To do this, highlight 'Skip to Neutral Set' and press the Adjust Dial.

To set the Left or Right position of the throw, highlight the direction and press the Adjust Dial to edit. Once in editing, use the Pulse Dial to make changes. Press the Adjust Dial to confirm or the BACK button to exit without saving.

After making changes to the servo's EPA settings, use the BACK button to return to the main screen. This will save the settings to the servo. Once back at the main screen, the recently saved changes will show below the EPA Neutral Settings.

Note: The Hitec Digital Servos are programmed to match a .9 to 2.1 millisecond pulse width with 1.5 millisecond pulse as neutral. When plugged into a receiver, the programmed positions might vary slightly due to manufacturing differences from radio to radio. EPA percentages and subtrim might have to be used for final adjustment.

2. Servo Sync

To match two brushless servos together, use the Servo Sync option when programming endpoints. The first step is to program and save the first servo at the desired positions. Exit the programming mode and then place the programmed servo into the SYNC slot of the HFP-30. Place the next servo into the servo slot and enter the programming mode. Enter the EPA and Neutral Setting menu and begin programming the servo. As the servo's endpoints are adjusted, you will see the servo in the SYNC slot move to its preprogrammed endpoints allowing easy matching of the new servo and those positions.

3. Rotation (CW_CCW)

```

=====
| CW_CCW_SET |
=====
< Now Values: CW >
> Set Values: CCW <
*LC<< CCW / CW >>R*

```

Highlight CW_CCW on the main screen and press the Adjust Dial to enter the menu. Under the Now Values will be the current rotation direction. Below will be the value to set. Use the Adjust Dial to change from CW to CCW. Once at the desired rotation, press the Adjust Dial to save the value to the Now Values. Press the BACK button to exit to the main menu.

4. Deadband (DB_Width):

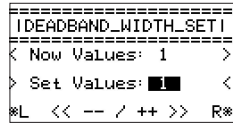

Highlight DB_Width on the main screen and press the Adjust Dial to enter the menu.

Note: Hitec Digital Servos from the factory are set to the tightest Deadband possible by default. Even if the Deadband can be set lower with the programmer, it will have no effect on the servo.

Once in the menu, the current Deadband is displayed under Now Values. Use the Adjust Dial to change the value under the 'Set Values'. When the desired Deadband is reached, press the Adjust Dial to save the value to 'Now Values'. Use the BACK button to exit to the main menu. Values for the Deadband are 1-10.

5. Speed:

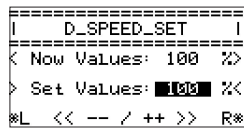

At times, it is required to slow a servo down for a desired application. Highlight Speed in the main menu and press the Adjust Dial. Once in the menu, the current speed is displayed under 'Now Values'. Use the Adjust Dial to change the value under the 'Set Values'. Once the desired speed is reached, press the Adjust Dial to save the value to Now Values. Use the BACK button to exit to the main menu. Values for speed are 10 – 100%.

6. ID (ID_Read):

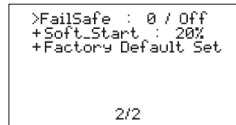

With D Series servos, you have the ability to assign an individual ID number. On the main menu, the current ID is displayed. To change it, highlight ID_Read and press the Adjust Dial to enter the menu. In the menu, adjust the ID number and press the Adjust Dial to assign it. Use the BACK button to exit to the main menu.

7. Failsafe:



Sometimes it is desired to have the servo go to a preset position with loss of signal. To program and turn on the feature enter the menu. To enter the menu, use the Adjust Dial to scroll to page 2 of the main menu and press the dial once highlighted. Follow the on-screen instructions and center the Pulse Dial. Current Failsafe settings are listed under 'Now Values'. Use the Pulse Dial to set the Failsafe position. Once set, use the Adjust Dial to turn Failsafe on or off. Press the Adjust Dial to save setting to the servo. The new setting will be displayed in the 'Now Values'. Use the Back button to exit the menu.

8. Soft Start:



The Soft Start feature, depending on the setting, allows the servo to either quickly or slowly move to the received signal when first turned on. Once it reaches the correct position, normal operation of the servo resumes. By default, this feature is enabled on D Series servos. To enter the menu, use the Adjust Dial to scroll to page 2 of the main menu and press the dial once highlighted. Current Soft Start settings are list under 'Now Values'. To change the values, turn the Adjust Dial to the desired percentage and press the dial to set it. The new setting will be displayed in the 'Now Values'. Use the Back button to exit the menu.

9. Factory Default (Factory Default Set):

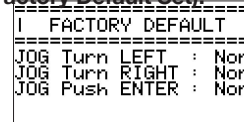

Sometimes it is best to restore the servo back to Factory Default settings. To enter the menu, use the Adjust Dial to scroll to page 2 of the main menu and press the dial once highlighted. Follow the on-screen prompts to reset the servo. Once each prompt is completed, the corresponding box will say ok. After the last one, the servo will be reset to factory defaults.

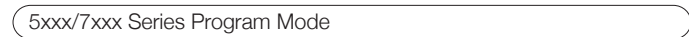

1. EPA Neutral Settings

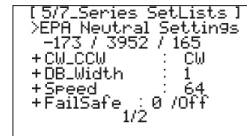

Press the Adjust Dial to enter the menu. If the Pulse Dial is off center, the program will ask that the dial be moved so the indicator is at 12 o'clock. Once adjusted, the Neutral Settings screen will appear. Use the Adjust Dial to elect either to change the Neutral position orto skip and move on to the endpoints.

To change the Neutral position, highlight NEUTRAL, press the Adjust Dial to enter edit mode. To make an adjustment, use the Pulse Dial. To save the setting to the servo, press the Adjust Dial, otherwise, press the BACK button to exit without making a change.

Note: Please note that changing the Neutral position to an extreme will affect the throw of the servo's endpoints. Try to never vary the position to far from nominal. Also, if the Neutral position is programmed, then the endpoints must be programmed.

The endpoints can be changed without setting the Neutral position. To do this, highlight 'Skip to Neutral Set' and press the Adjust Dial. To set the Left or Right position of the throw, highlight the direction and press the Adjust Dial to edit. Once in editing, use the Pulse Dial to make changes. Press the Adjust Dial to confirm or the BACK button to exit without saving.

2. Servo Sync

To match two servos together, use the Servo Sync option when programming Neutral and Endpoints. The first step is to program and save the first servo at the desired positions. Exit the programming mode and then place the programmed servo into the SYNC slot of the HFP-30. Place the next servo into the Servo slot and enter the programming mode. Enter the EPA and Neutral Setting menu and begin programming the servo. As the servos neutral and endpoints are adjusted, you will see the servo in the SYNC slot move to its preprogrammed center and endpoints allowing easy matching of the new servo and those positions.

3. Rotation (CW_CCW)

```

=====
|   CW_CCW_SET   |
=====
< Now Values: CW >
> Set Values: CW <
*L<< CCW / CW >>R*
    
```

Highlight CW_CCW on the main screen and press the Adjust Dial to enter the menu. Under the Now Values will be the current rotation direction. Below will be the value to set. Use the Adjust Dial to change from CW to CCW. Once at the desired rotation, press the Adjust Dial to save the value to the Now Values. Press the BACK button to exit to the main menu.

4. Deadband (DB_Width):

```

=====
| DEADBAND_WIDTH_SET |
=====
< Now Values: 1 >
> Set Values: 1 <
*L << -- / ++ >> R*
    
```

Highlight DB_Width on the main screen and press the Adjust Dial to enter the menu.

Note: Hitec Digital Servos from the factory are set to the tightest Deadband possible by default. Even if the Deadband can be set lower with the programmer, it will have no effect on the servo.

Once in the menu, the current Deadband is displayed under Now Values. Use the Adjust Dial to change the value under the Set Values. Once the desired Deadband is reached, press the Adjust Dial to save the value to Now Values. Use the BACK button to exit to the main menu. Values for the Deadband are 1-16.

5. Speed:

```

=====
|   D_SPEED_SET   |
=====
< Now Values: 100 >
> Set Values: 100 <
*L << -- / ++ >> R*
    
```

Highlight Speed in the main menu and press the Adjust Dial. Once in the menu, the current Speed is displayed under Now Values. Use the Adjust Dial to change the value under the Set Values. Once the desired speed is reached, press the Adjust Dial to save the value to Now Values. Use the BACK button to exit to the main menu. Values for the speed are 1 – 64, with 1 being the slowest and 64 the fastest.

6. Failsafe

```

=====
|   D_FAILSAFE_SET |
=====
< Now Values: 2101/On >
> Set Values: 1491 <
> Set On/Off: On <
*L << On / Off >> R*
    
```

Sometimes it is desired to have the servo go to a preset position when it loses signal. To enter the menu, use the Adjust Dial to scroll to page 2 of the main menu and press the dial once highlighted. Follow the on-screen instructions and center the Pulse Dial. Current Failsafe settings are listed under 'Now Values'. Use the Pulse Dial to set the Failsafe position. Once set, use the Adjust Dial to turn Failsafe on or off. Press the Adjust Dial to save the setting to the servo. The new setting will be displayed in the 'Now Values'. Use the Back button to exit the menu.

7. High Resolution:

```

>High_Resolution : Off
+OLP Set : Off
+Factory Default Set

2/2
    
```

Hitec 7xxx Series Digital Servos have a high resolution circuit that can be turned on or off. When on, total programmable throw is 120

degrees. If turned off, total programmable throw is 180 degrees. To adjust the resolution, highlight the High_Resolution menu and press the Adjust Dial to enter. The current status is displayed under 'Now Status'. To change the status, use the Adjust Dial to change the highlighted on or off and press the dial to save. Use the Back button to exit the menu.

8. Overload Protection:

```

=====5xxx/7xxx=====
| OVERLOAD_PROTECT_SET |
=====
< Now Values: 10% >
> Set Values: 10% <
*Range to 0~50%*
    
```

Hitec 7xxx Series Digital Servos can be programmed with Overload Protection. By default, this setting is set to off. To adjust the Overload Protection, highlight 'OLP Set' and press the Adjust Dial. The current status is displayed under 'Now Status'. Use the Adjust Dial to change to the desired value and press the dial to save. The OLP range is off – 50%, in 10% increments.

9. Factory Default (Factory Default Set):

```

=====
|   FACTORY_DEFAULT |
=====
JOG Turn LEFT : None
JOG Turn RIGHT : None
JOG Push ENTER : None
    
```

Sometimes it is best to restore the servo back to Factory Default settings. To enter the menu, use the Adjust Dial to scroll to page 2 of the main menu and press the dial once highlighted. Follow the on-screen prompts to reset the servo. Once each prompt is completed, the corresponding box will say ok. After the last one, the servo will be reset to factory defaults.

Brushless (BLDC) Series Program Mode

1. EPA Neutral Settings

```

HSB-9465
>EPA Neutral Settings
-98 / 2048 / 88
+CW_CCW : CW
+DB_Width : 1
+Speed : 100%
+FailSafe : 0 / Off
1/2
    
```

Press the Adjust Dial to enter the menu. If the Pulse Dial is off center, the program will ask that the dial be moved so the indicator is at 12 o'clock. Once adjusted, the Neutral Settings screen will appear. Use the Adjust Dial to elect either to change the neutral position or to skip and move on to the endpoints. To change the neutral position, highlight NEUTRAL, press the Adjust Dial to enter edit mode. To make an adjustment, use the PULSE dial. To save the setting to the servo, press the Adjust Dial, otherwise, press the BACK button to exit without making a change.

Note: Changing the neutral position to an extreme will affect the throw of the servo's endpoints. Try to never vary the position too far from nominal. Also, if the neutral position is programmed, then the endpoints must be programmed.

The endpoints can be changed without setting the neutral position. To do this, highlight 'Skip to Neutral Set' and press the Adjust Dial.

To set the left position, highlight LEFT and press the Adjust Dial. To activate, turn the Pulse Dial all the way to the left (counterclockwise). Once activated, turn the Pulse Dial to the right (clockwise) to set the desired throw in the left position. Press the Adjust Dial to save the setting or press the BACK button to exit without saving.

To set the right position, highlight RIGHT and press the Adjust Dial. To activate, turn the Pulse Dial all the way to the right (clockwise). Once activated, turn the Pulse Dial to the left (counterclockwise) to set the desired throw in the right position. Press the Adjust Dial to save the setting or press the BACK button to exit without saving.

2. Servo Sync

To match two servos together, use the Servo Sync option when programming Neutral and Endpoints. The first step is to program and save the first servo at the desired positions. Exit the programming mode and then place the programmed servo into the SYNC slot of the HFP-30. Place the next servo into the Servo slot and enter the programming mode. Enter the EPA and Neutral Setting menu and begin programming the servo. As the servo's neutral and endpoints are adjusted, you will see the servo in the SYNC slot move to its preprogrammed center and endpoints allowing easy matching of the new servo and those positions.

3. Rotation (CW_CCW):

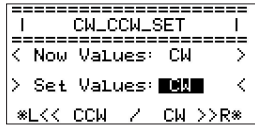

Highlight CW_CCW on the main screen and press the Adjust Dial to enter the menu. Under the Now Values will be the current rotation direction. Below will be the value to set. Use the Adjust Dial to change from CW to CCW. Once at the desired rotation, press the Adjust Dial to save the value to the Now Values. Press the BACK button to exit to the main menu.

4. Deadband (DB_Width):

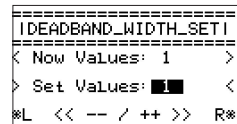

Highlight DB_Width on the main screen and press the Adjust Dial to enter the menu.

Note: Hitec Digital Servos from the factory are set to the tightest Deadband possible by default. Even if the Deadband can be set lower with the programmer, it will have no effect on the servo.

Once in the menu, the current Deadband is displayed under Now Values. Use the Adjust Dial to change the value under the Set Values. Once the desired Deadband is reached, press the Adjust Dial to save the value to Now Values. Use the BACK button to exit to the main menu. Values for the Deadband are 1-20.

5. Speed:



Highlight Speed in the main menu and press the Adjust Dial. Once in the menu, the current speed is displayed under Now Values. Use the Adjust Dial to change the value under the Set Values. Once the desired speed is reached, press the Adjust Dial to save the value to Now Values. Use the BACK button to exit to the main menu. Values for speed are 10 - 100%.

6. Failsafe:



Sometimes it is desired to have the servo go to a preset position when it loses signal.

To enter the menu, use the Adjust Dial to scroll to page 2 of the main menu and press the dial once highlighted. Follow the on-screen instructions and center the Pulse Dial. Current Failsafe settings are

listed under 'Now Values'. Use the Pulse Dial to set the Failsafe position. Once set, use the Adjust Dial to turn Failsafe on or off. Press the Adjust Dial to save setting to servo. The new setting will be displayed in the 'Now Values'. Use the Back button to exit the menu.

7. Soft Start:



The Soft Start feature, depending on the setting, allows the servo to either quickly or slowly move to the received signal when first turned on. Once it reaches the correct position, normal operation of the servo resumes. By default, this feature is enabled on D Series servos. To enter the menu, use the Adjust Dial to scroll to page 2 of the main menu and press the dial once highlighted. Current Soft Start settings are listed under 'Now Values'. To change the values, turn the Adjust Dial to the desired percentage and press the dial to set it. The new setting will be displayed in the 'Now Values'. Use the Back button to exit the menu.

8. Factory Default (Factory Default Set):

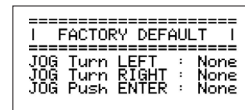

Sometimes it is best to restore the servo back to Factory Default settings. To enter the menu, use the Adjust Dial to scroll to page 2 of the main menu and press the dial once highlighted. Follow the on-screen prompts to reset the servo. Once each prompt is completed, the corresponding box will say OK. After the last one, the servo will be reset to factory defaults.

NOTES:

Contact Information

Hitec RCD USA, Inc. | 12115 Paine St., Poway CA, 92064
www.hitecrd.com | 858.748.6948 | service@hitecrd.com